

37.5mm RIFFLE SPLITTER

Model: 603



FEATURES

- A sampling device used for sample splitting and acquiring a representative sample
- Battery of twenty open chambers of 37.5 mm
- Powder coated steel construction

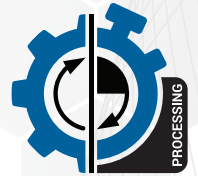

NOTE

- Supplied with three bins
- Sample is equally divided into two subsamples



ALL SCIENTIFIC EQUIPMENT COMES WITH A TWO
YEAR WARRANTY ON COMPONENTS AND
DEFECTIVE WORKMANSHIP - Ts & Cs APPLY.

www.scientific.co.za



37.5mm RIFFLE SPLITTER

Model: 603

SPECIFICATIONS

PACKAGING (W x D x H)	925 x 450 x 500 (mm)
UNIT (W x D x H)	925 x 450 x 450 (mm)
NET WEIGHT	14kg
GROSS WEIGHT	14kg
SHIPPING VOLUME	0.21m ³
CHAMBER SIZE	37.5 (mm)
NUMBER OF SLOTS	20

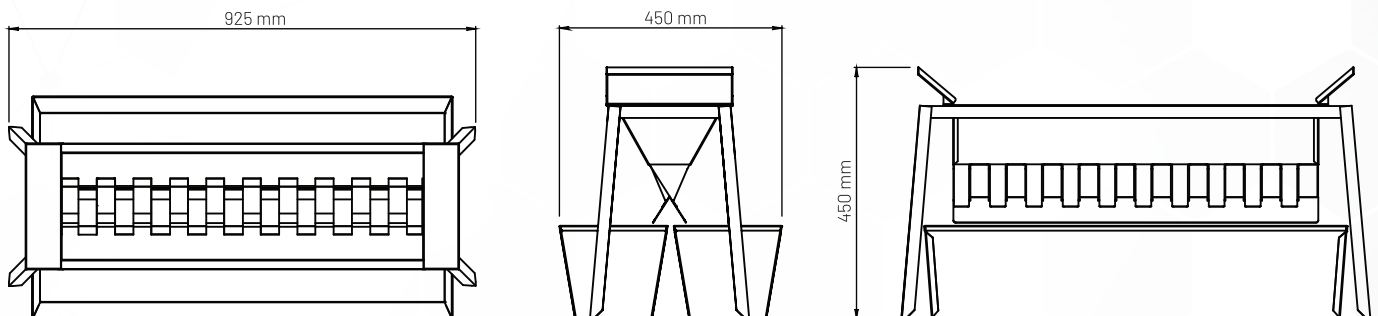

NOTE

- When viewing the appliance from the front in its usual operating position, the width (W) of the product is the total distance from left to right; the depth (D) of the product is the total distance from the front to the back; the height (H) is the total distance from the bottom of the product to the top. Pictures may vary from actual product.

DISCLAIMER

- Output performance figures quoted are dependent on various factors. Scientific reserves the right, without notice, to make changes and revisions to product specifications, materials and design, when we believe it will provide better performance, durability, and efficiency. Unit measurements may vary depending on point of reference.

WARRANTY

- All Scientific equipment comes with a standard ONE year warranty, The 1 Year Extended Warranty is only valid for customers who have registered their warranty online at www.scientific.co.za within the first year after making their purchase.